

GONDOLA / WALL FIXTURE

PAGE 1 OF 14

ASY 046

INSTALLATION INSTRUCTIONS

PAGE 2
UNLOADING/
CARTON
LABELING

PAGE 3-5
PARTS
IDENTIFICATION

PAGE 6-9
BASIC
INSTALLATION

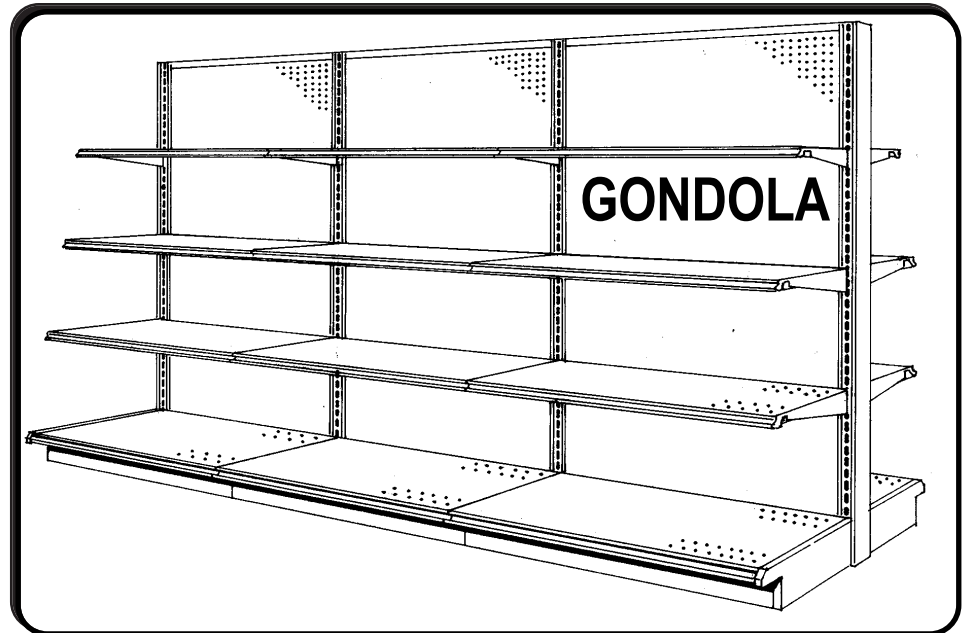

NOTE! This publication is intended to be a generic installation instruction for Madix gondola and wall shelving, and may possibly be subject to change as required by the local building codes. Consult the building inspection department at the job site.

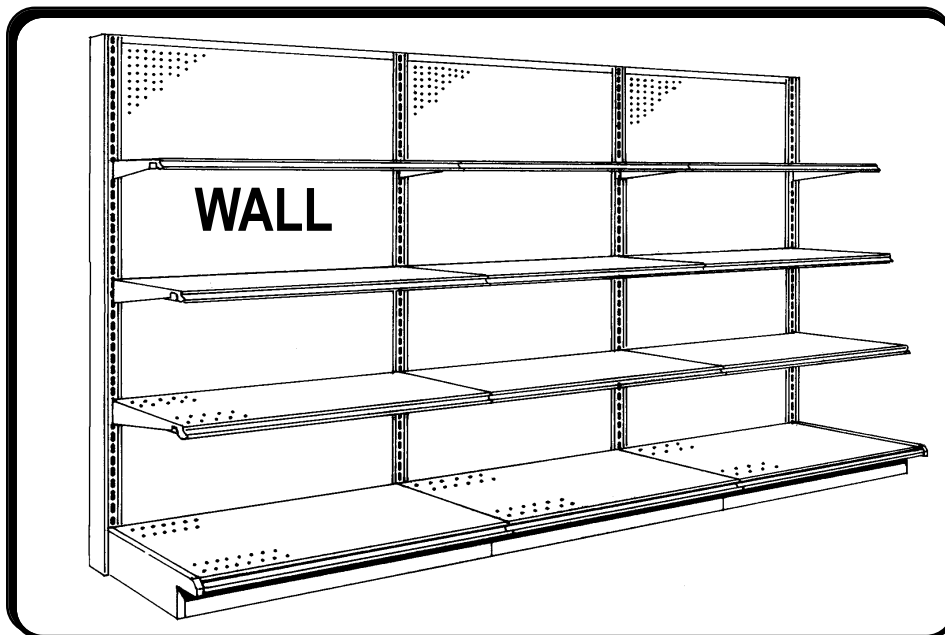

PAGE 10
WALL RUN
ANCHORING

PAGE 11
SAFETY/
SHELF
LOADING

PAGE 12-14
SAFETY/
FIXTURE
LOADING

GONDOLA / WALL FIXTURE

ASY 046

UNLOADING / CARTON LABELING

IMPORTANT! When unloading, stack all boxes...

1. WITH THE LABELS VISIBLE.
2. WITH THE SAME OPENING SEQUENCE NUMBER TOGETHER.
3. WITH THE SAME DESCRIPTION TOGETHER.
4. WITH THE SAME PART NUMBER TOGETHER.

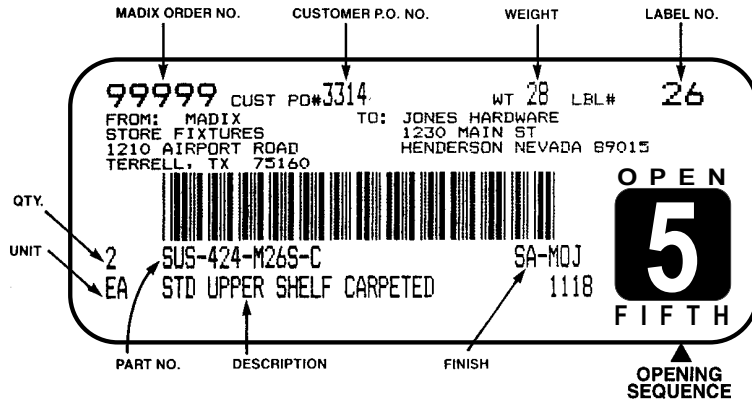

NOTE!
THE STANDARD PRODUCTS LISTED BELOW WILL ALTER THE INSTALLATION PROCEDURE SHOWN. Specific instructions covering any products listed below, if ordered, are included with this document package. Refer to them prior to beginning installation since your procedure will be altered.

END MERCHANDISER
ASY 063

CANOPIES
ASY 092

TELESCOPING UPRIGHTS
ASY 027

BOX CORNER
ASY 098

METAL END FLAT
ASY 019

INSIDE CORNER
ASY 062

OPEN BACK STIFFENER
ASY 042

OUTSIDE CORNER
ASY 059

FLOOR ANCHORS
ASY 357

WIRE GRID BACKS
ASY 328

OUTSIDE MOUNT END
MERCHANDISER
ASY 064

TRIPLE BACK SYSTEM
ASY 325

THERE IS NO OPENING SEQUENCE ON CHECKOUTS, SHOWCASES, COUNTERS, REGISTER STANDS, CORNER FILLS, GATES OR SPECIAL WOOD PRODUCTS.

OPEN
1
FIRST

- BASIC UPRIGHTS
- BASE SHOES
- ALL SPANNERS
- KICKPLATES
- UPRIGHT END COVERS
- BASE END COVERS
- BOX CORNER
- INSIDE CORNER
- OUTSIDE CORNERS
- EXTENSION UPRIGHTS
- TELESCOPING UPRIGHTS
- OPEN BACK STIFFENER
- WALL SECTION RETAINER PIN

OPEN
2
SECOND

- ALL BACK PANELS
- ALL EXTENSION BACK PANELS

OPEN
3
THIRD

- CANOPIES
- CANOPY FLANGES
- CANOPY BRACKETS
- FLUORESCENT FIXTURES
- FLUORESCENT TUBES

OPEN
4
FOURTH

- FLOOR ANCHORS
- BASE SHELVES
- END PANELS
- CANOPY ENDS
- CANOPY END PANELS
- END MERCHANDISERS
- METAL END FLATS

OPEN
5
FIFTH

- UPPER SHELVES
- ALL ACCESSORIES FOR USE IN UPRIGHT SLOTS

GONDOLA / WALL FIXTURE

ASY 046

PARTS IDENTIFICATION

- THE PARTS SHOWN BELOW REPRESENT A WALL, SINGLE SIDED, SECTION.
- BOTH GONDOLA AND WALL SECTIONS USE THE SAME PARTS.
- PAGES 6-9 SHOW INSTALLATION OF A GONDOLA, DOUBLE SIDED, FIXTURE.

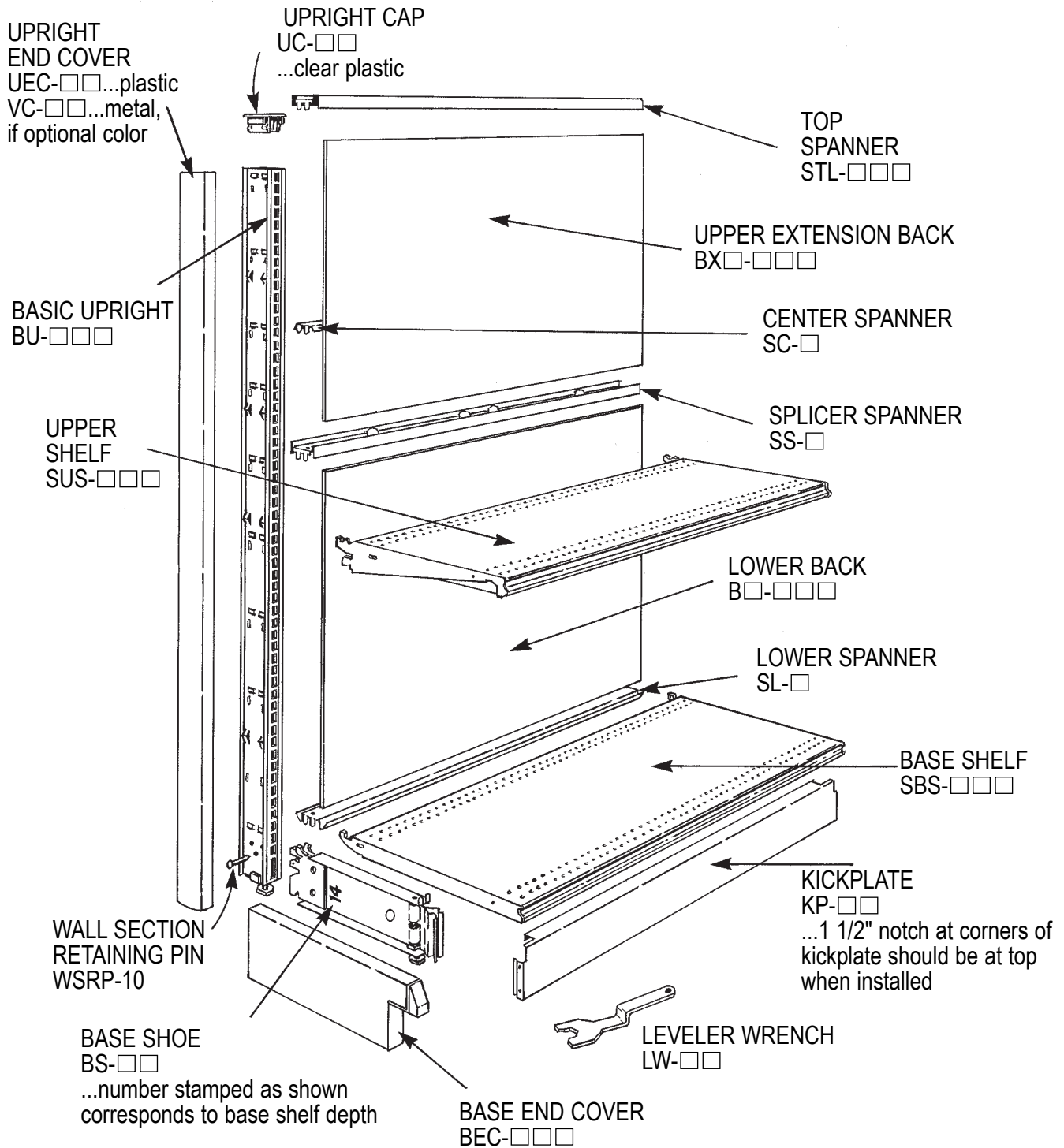

GONDOLA / WALL FIXTURE

ASY 046

SPANNER / BACK PANEL IDENTIFICATION

....for gondola or wall units from 36" to 144" high.

78" UPRIGHT

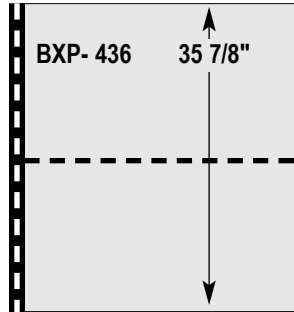

INDICATES CENTER SPANNER ...3' or 4'
... at approximate midpoint of back.

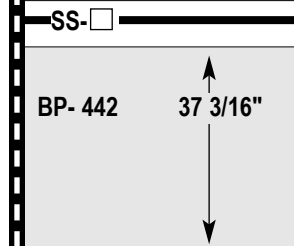

INDICATES SPLICER SPANNER ...3' or 4'

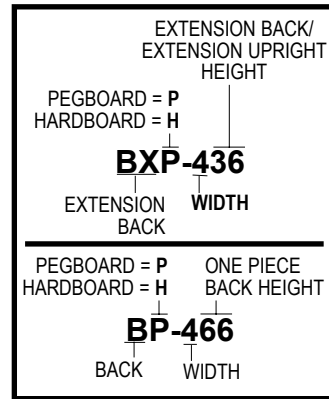
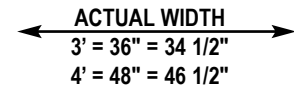

- NOTES!**
- Centered and flush wire grid panels will have slightly different dimensions... see ASY 328.
 - Triple back system panels will have slightly different dimensions... see ASY 325.

TOP AND LOWER SPANNERS ARE NOT SHOWN!

36" UPRIGHT

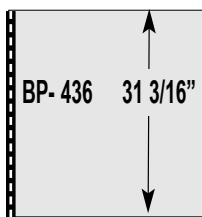

42" UPRIGHT

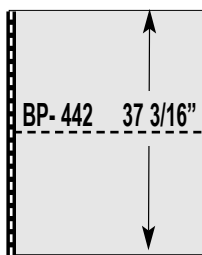

48" UPRIGHT

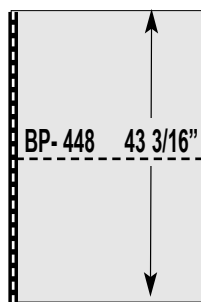

54" UPRIGHT

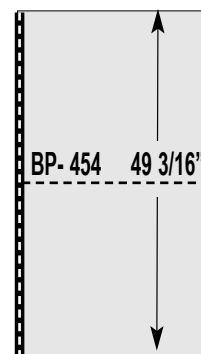

114" UPRIGHT

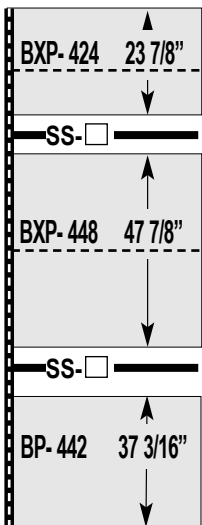

108" UPRIGHT

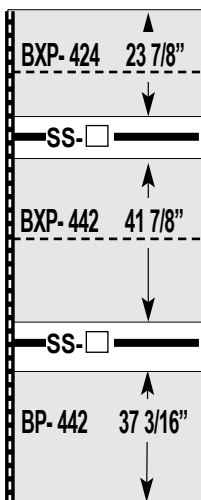

102" UPRIGHT

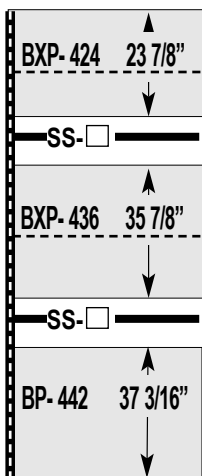

96" UPRIGHT

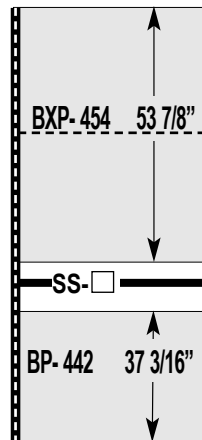

90" UPRIGHT

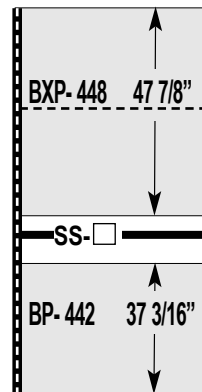

GONDOLA / WALL FIXTURE

ASY 046

SPANNER / BACK PANEL IDENTIFICATION

...for gondola or wall units from 36" to 144" high.

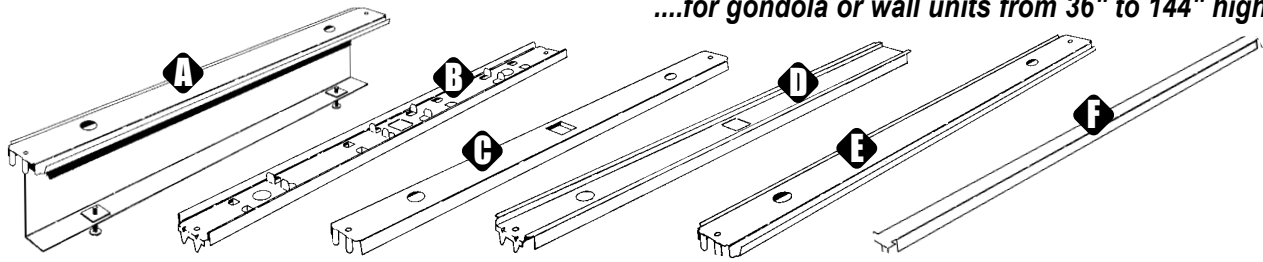

- A** HSL-□ HEAVY DUTY LOWER SPANNER ...slatwall and wire grid only
- B** SS-□...SPLICER SPANNER **C** SC-□...CENTER SPANNER **D** STL-□...TOP SPANNER
- E** SL-□...LOWER SPANNER **F** SSC-□...SLATWALL CENTER SPANNER

60" UPRIGHT

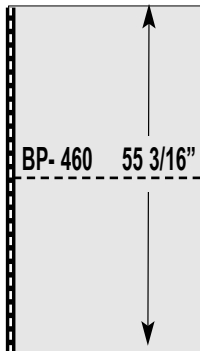

66" UPRIGHT

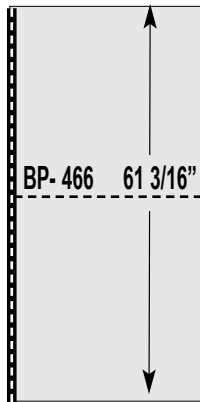

72" UPRIGHT

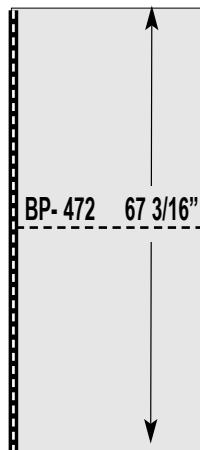

78" UPRIGHT

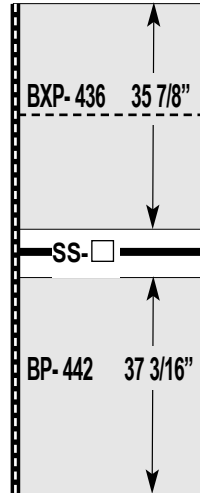

84" UPRIGHT

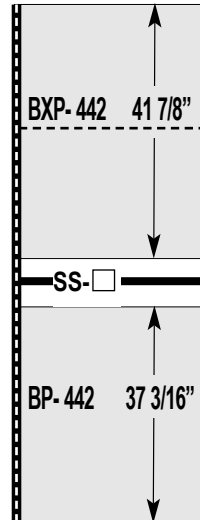

144" UPRIGHT

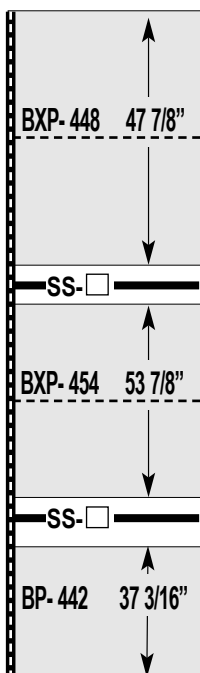

138" UPRIGHT

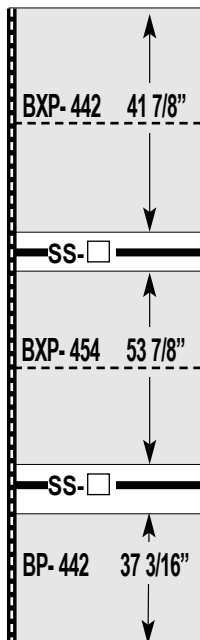

132" UPRIGHT

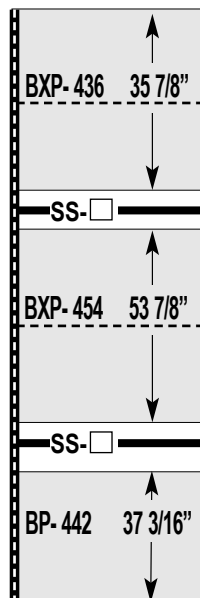

126" UPRIGHT

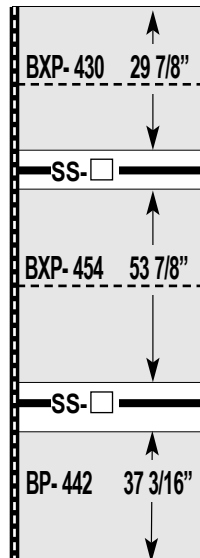

120" UPRIGHT

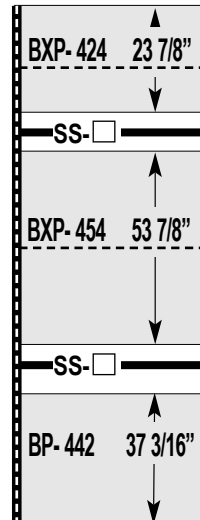

GONDOLA / WALL FIXTURE

ASY 046

BASIC INSTALLATION

1 In addition to the leveler wrench provided, a large screwdriver is required for base shoe levelers...also required are a chalkline, a long measuring tape, a heavy nylon line and piece of shingle or lath...see step 13.

2 Snap chalklines on the floor for fixture alignment, using diagram at left as guide...ALLOW 1 5/8" FOR KICKPLATE RECESS.

3 Lay out parts as shown above, with kickplates and spanners end to end. All uprights should overlap as shown in side view so the bottom of each upright will stand at the kickplate joints... IF RUN IS 78" OR HIGHER, lay out splicer spanners in addition to center spanner.

4 Lay one back for first section nearby...IF THE RUN IS 78" OR HIGHER...ONLY LOWER BACK IS REQUIRED FOR SQUARING...extension back is not required.

5 Insert base shoes into all uprights ...shoes do not have to be locked in at this time....run upright levelers out approximately 1/4".

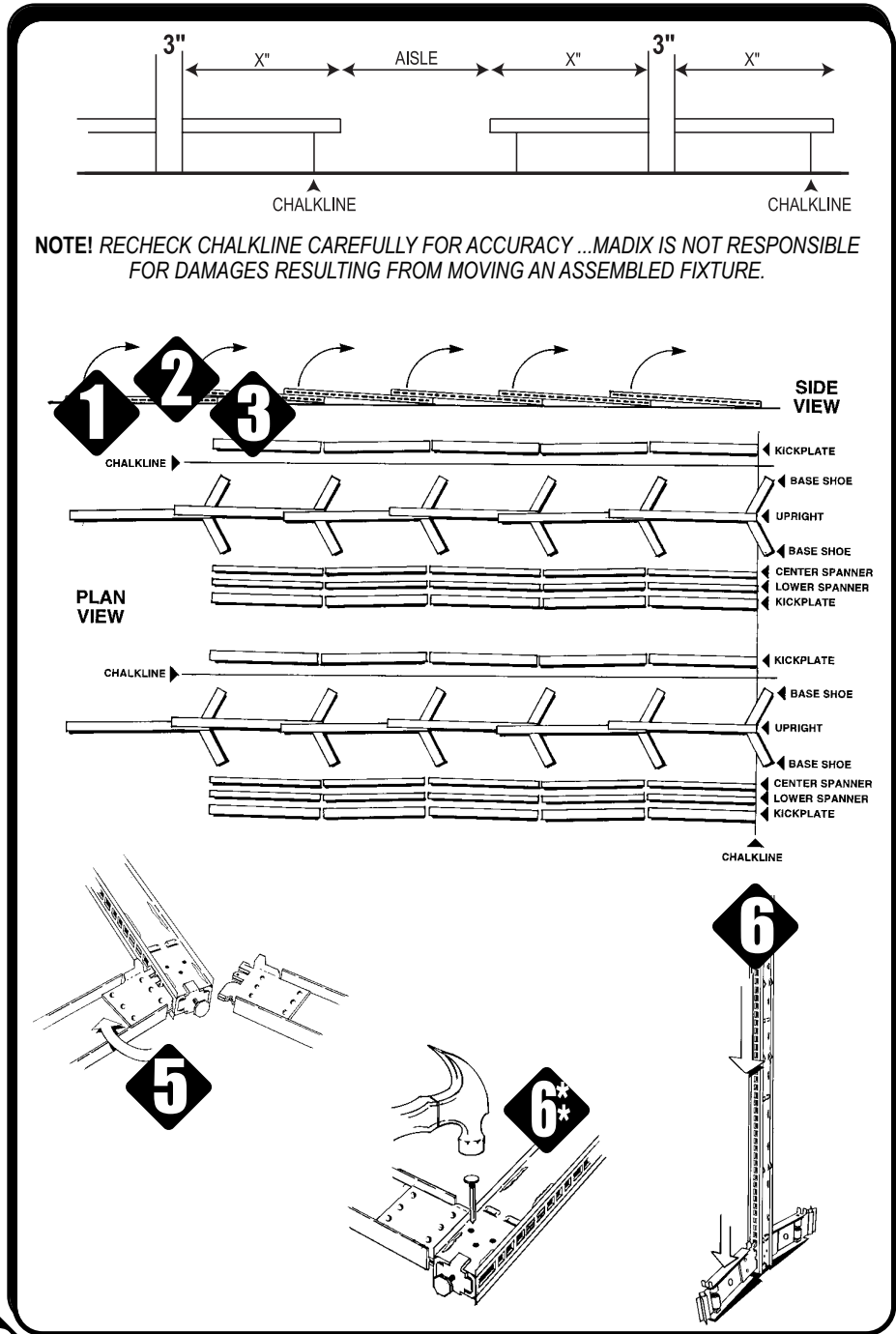

6 Raise first upright to vertical and push down sharply. Base shoes should lock in, if they do not lock in, step firmly on top of shoe to lock.

****NOTE!** If wall run, lay upright on floor and drive WSRP pin through the upright and base shoe as shown ...all uprights. **Do not** drive the WSRP pin in until it is fully seated. Leave 1/8" to 1/4" gap between pin head and side panel!

GONDOLA / WALL FIXTURE

ASY 046

BASIC INSTALLATION

7 Raise second upright to vertical, lock base shoes and install center spanner. BOTH SPANNER TABS MUST BE SHOWING BELOW LANCES...DO NOT HAMMER DOWN ON SPANNER!

8 Install lower spanner...IN SINGLE BACK INSTALLATIONS, THE SPANNER TAB OPPOSITE THE BACK SHOULD BE BENT UPWARD TO PREVENT THE SPANNER FROM ROLLING.

9 Install the back panel from step 4. Slide down from top...DO NOT DROP BACKS ONTO THE LOWER SPANNER!

10 Erect remaining uprights in run, installing center and lower spanners between the uprights.

NOTE!
On runs of six or more sections, stabilize by adding back in the last section.

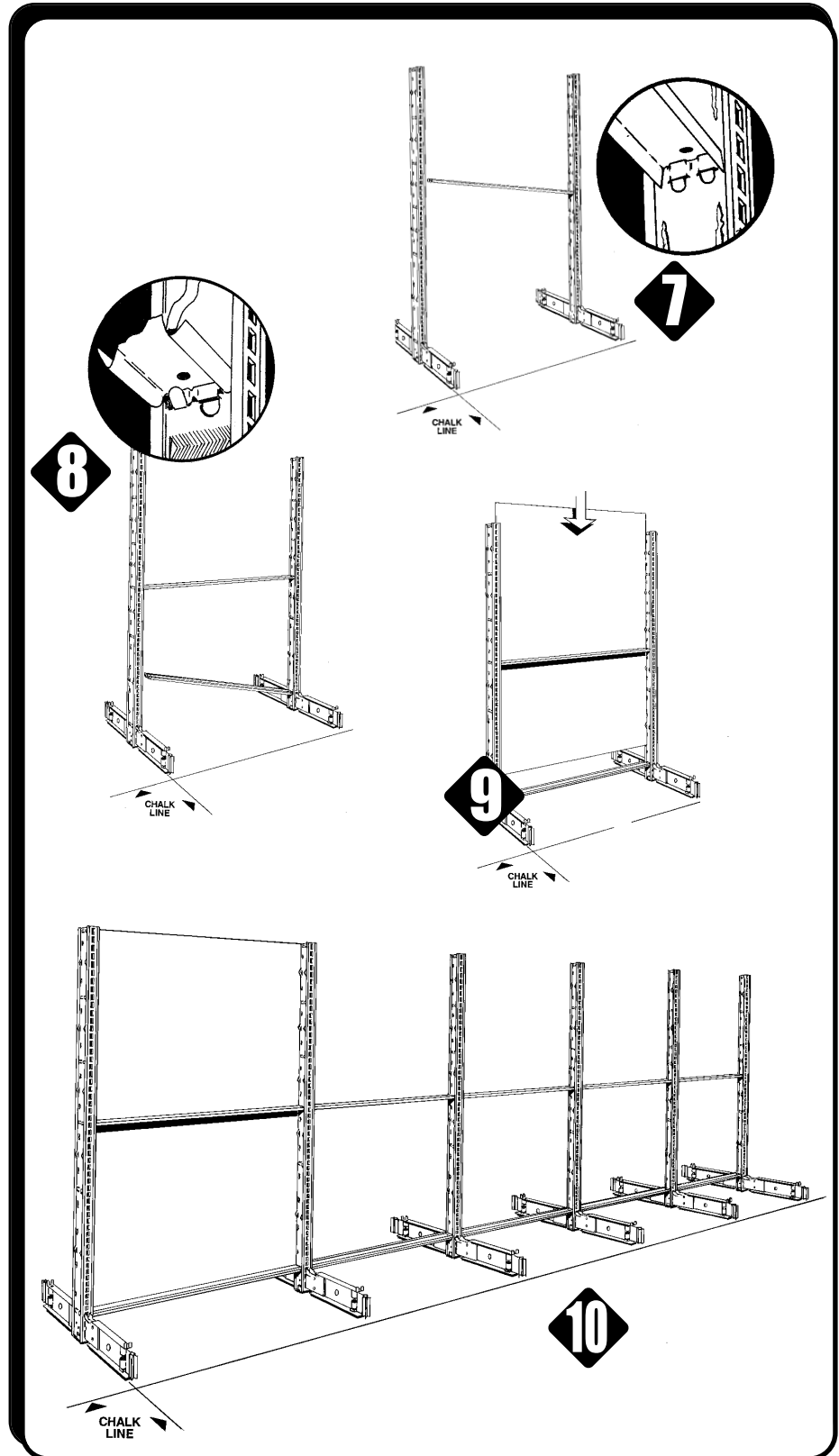

GONDOLA / WALL FIXTURE

ASY 046

BASIC INSTALLATION

11

Install all kickplates... kickplates snap directly in from front... 1 1/2" notch at the corners of kickplate should be at top when installed.

12

Pull both end uprights forward to bring the kickplates to the chalkline, then plumb using a level against face of upright and adjusting the base shoe levelers.

13

Attach the nylon line to end upright as shown. Attach line at corresponding slot on opposite end upright, draw taut and secure.

14

Examine all uprights at nylon line to determine the highest upright in run, excluding end uprights. Pull this highest upright forward until kickplate is on the chalkline. If run is a gondola, plumb at base shoe levelers ...if run is a wall, plumb at upright and base shoe levelers.

IMPORTANT!

If floor anchors are required, try them when plumbing the highest upright to be sure that the end slots fit tight around the leveler threads and over the leveler head. Checking this on the highest upright assures that all the other levelers will accept the anchors. Consult ASY-357 for anchor positioning.

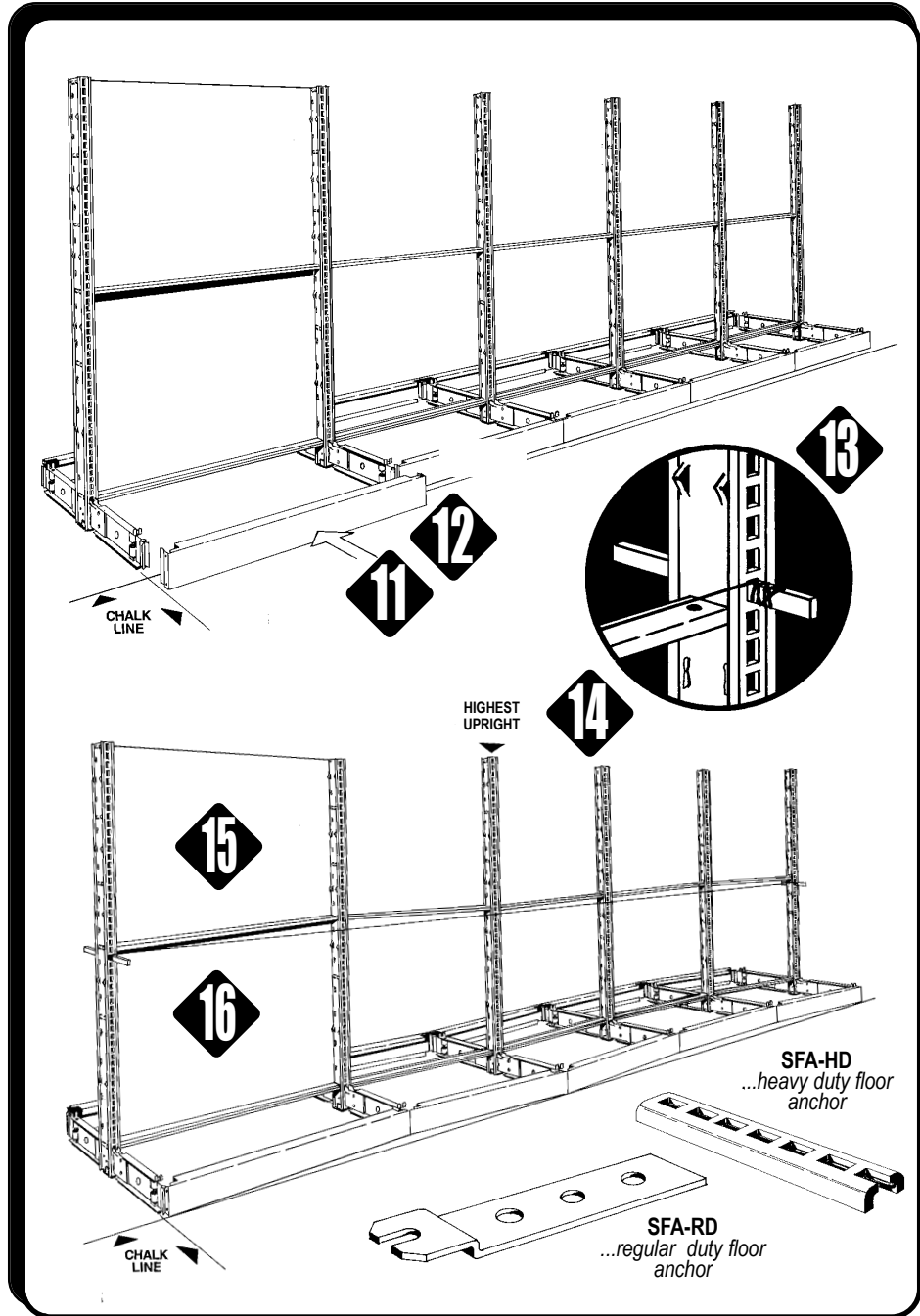

15

Working with the remaining uprights in succession, bring kickplates up to chalkline, then adjust for height at upright leveler and plumb at base shoes.

16

Raise or lower end uprights until slots on ends and highest upright correspond relative to the nylon line. THEN REPLUMB BOTH END UPRIGHTS!

GONDOLA / WALL FIXTURE

ASY 046

BASIC INSTALLATION

17

If the fixture run is a gondola and floor anchors are not required, ADJUST ALL UPRIGHT LEVELERS TO 1/4" CLEARANCE ABOVE THE FLOOR!

18

Remove the nylon line...install all remaining backs. DO NOT DROP BACKS ONTO LOWER SPANNERS!

19

Install upright end covers, plastic or metal, at each end of the run by snapping directly on, beginning at the top.

20

For METAL upright end covers, install the UC, upright cap, downward into the end basic upright, being sure the small outside flanges insert into the slot in the top flange of the VC-□ □ .

For PLASTIC upright end covers, install the UC, upright cap, downward into the end basic upright. There is no slotted top flange on this style.

21

Install base end covers.

22

Verify alignment of the kickplates to the chalkline and if floor anchors are to be used, install them now. See installation instruction ASY-357 for correct positioning.

23

Install base shelves ...visually check the base shelf alignment.

24

Install upper shelves and/or accessories.

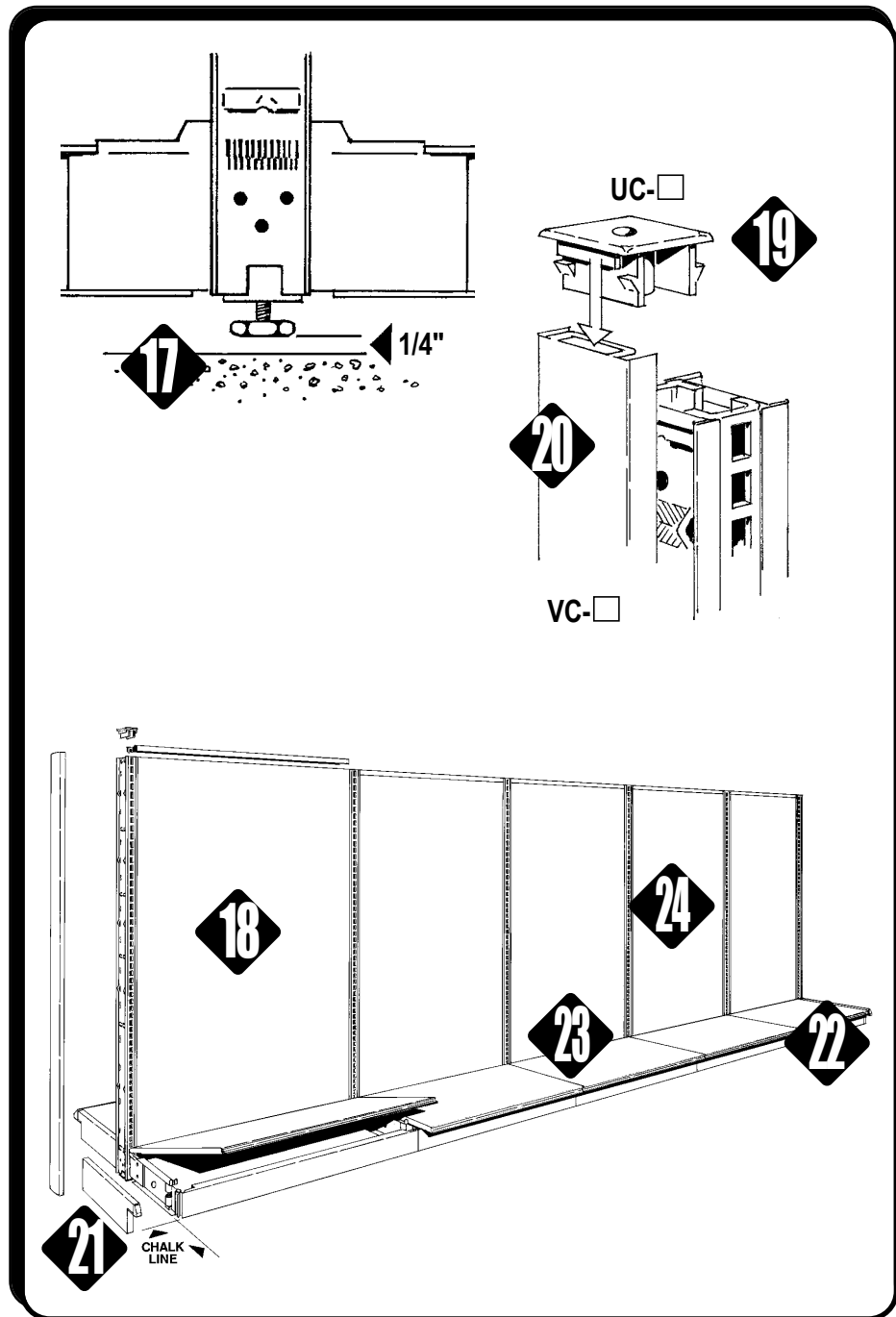

GONDOLA / WALL FIXTURE**ASY 046**

W A L L R U N A N C H O R I N G

**IF CANOPY IS TO BE USED,
CONSULT INSTALLATION
INSTRUCTION ASY 092
PRIOR TO PROCEEDING**

Uprights will be anchored to a single run of 2 x 4 furring strips secured at approximately 8" below the top of the uprights, subject to leveling.

- *Determine run length and location...then strike a chalkline on the wall at upright height, minus 8", to align the top edge of the furring strips.
- *Start with a 10' long 2 x 4, finishing the rest of run with 8' long 2 x 4's, this insures that uprights will not be on a joint.

NOTE! It is not necessary to secure furring strips at ends of run...only as closely as the locations indicated below.

IF DRYWALL...**A. Determine stud spacing.**

- *If 16" stud spacing, mark every other stud.
- *If 24" stud spacing, mark every stud.

B. Secure furring strips to wall at marked stud locations with 3" or 3 1/2" x #6 drywall screws.

- *To prevent splitting wood, drill a 1/8" pilot hole...bit will meet minimal resistance if studs are wood.
- *Stop drilling if bit hits metal stud...if light duty stud, then drywall screw will penetrate...if screw will not penetrate, the studs are heavy duty and will require pilot drilling through stud for screw to penetrate.

C. Proceed with installation of wall fixture per the gondola instructions, steps 1 through 11, except,

- *Be sure WSRP pin is installed per step 6.
- *No chalkline is necessary...set back of uprights approximately 1" away from furring strips.
- *If using basic upright wall mount support, BUWMS, install in rear side of upright in 10th slot from top.

D. Push fixture back against furring strips and proceed with plumb and level steps 12 through 16, visually sighting kickplate alignment.

- *If using BUWMS wall mount support, secure to furring strips with 1 1/2" x #12 sheet metal screws, drill 5/32" pilot hole, shimming behind the BUWMS as necessary.
- *If not using BUWMS, secure upright to furring strip with 4" x 5/16" lag screws and washers into 10th slot from top...drill 1/4" pilot hole.

E. Complete steps 17 through 21.

- *If base shelves have a wedge shaped gap, it will be necessary to push in at the gap and/or pull out at the adjacent joints...readjustment of the base shoe levelers may be necessary.

IF CONCRETE BLOCK...or other masonry**A. Secure furring strips to wall with 3" long "TAPCON" masonry screws at approximately 24" intervals, only at block locations specified on diagram. "TAPCON"s do not require an anchor.**

- *For 3/16" screws...use 5/32" masonry bit for pilot hole.
- *For 1/4" screws... use 3/16" masonry bit for pilot hole.

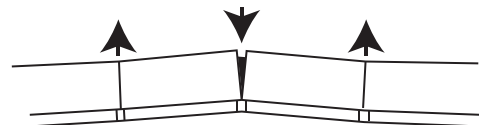
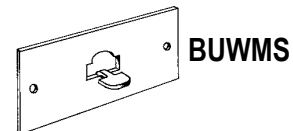
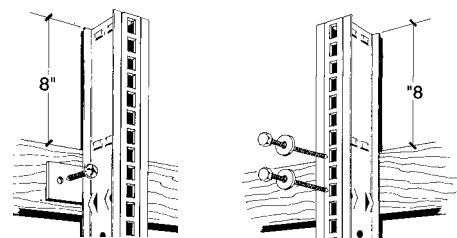
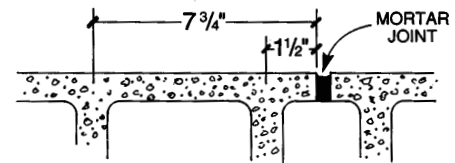
B. For other masonry... block locations do not apply. Secure furring at 24" intervals with "TAPCON"s per step A above.

ALTERNATE METHOD... Follow instructions above, except, (1) Strike the chalkline on wall at upright height, minus 2".... this line is to mark "TAPCON" locations...furring strips will be slightly lower. (2) Skip step B and omit use of BUWMS or lag screw. (3) Cut 2 x 4's to section lengths...46 1/2" for 4', 34 1/2" for 3'. (4) Set 2 x 4 on second spanner lance from top of upright and secure to the wall using the appropriate fasteners and locations for the wall types indicated above. (5) Complete per step E.

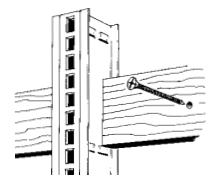

madix™
STORE FIXTURES

P.O. BOX 729 / TERRELL, TEXAS 75160 / 972.563.5744 / 800.776.2349
P.O. BOX 177 / GOODWATER, ALABAMA 35072 / 205.839.6354 / 800.633.6282

**REV
D**

GONDOLA / WALL FIXTURE

ASY 046

FIXTURE LOADING - PRODUCT SAFETY

GENERAL

- 1) Contact the local building department prior to starting installation to check on any restrictions.
- 2) Only parts and accessories produced or supplied by Madix are covered by Madix warranty.
- 3) Installation sequence must be followed exactly for assembly and leveling.
- 4) Under no circumstances should damaged parts be used.
- 5) Do not use shelving parts or accessories for any purpose other than originally intended.
- 6) Installation instructions with product load ratings are included with each order and must be followed carefully.
- 7) Merchandisers must be made aware of possible overloading as specified in load ratings. If you do not receive these, please contact your sales or customer service representative.
- 8) Initial installation or relocation of Madix gondola or wall fixtures should be supervised exclusively by qualified personnel.

GONDOLA /WALL SHELVING

- 9) Never install shelves or accessories into the side of an upright that has no base shoes on that side.
- 10) Be sure all shelving parts or accessories are completely seated in slotting or perforations.
- 11) Do not permit climbing or standing on shelving at any time...especially base shelves.
- 12) Do not attempt to relocate merchandised shelves or accessories.
- 13) Never try to move completed fixtures, especially if merchandised.
- 14) No shelves or accessories should project past the front of the base shelf.
- 15) Base end covers and upright end covers must always be installed at the end of a run.
- 16) All displayers at a gondola end must have a base shelf, metal end flat or other type of flat to prevent collisions with any upper shelves or accessories, if these are to be installed.

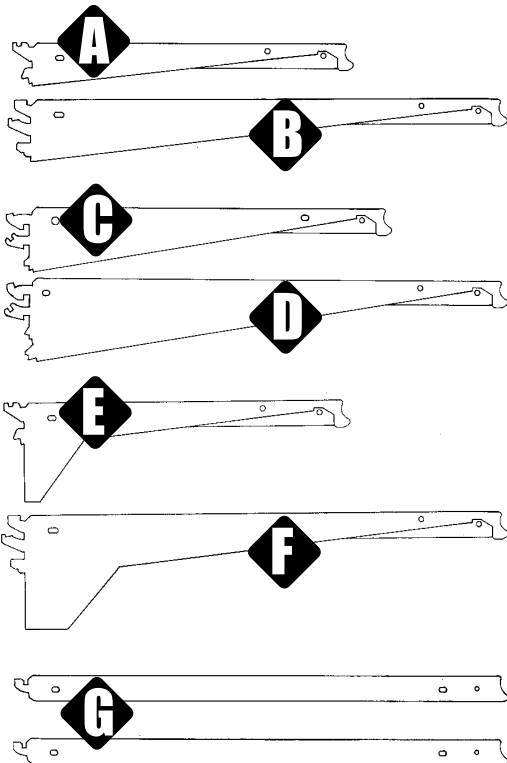

NOMINAL SHELF DEPTHS, all types...
 8", 10", 12", 14", 16", 18", 20", 22", 24", 26", 28", 30"

MAXIMUM LOAD CAPACITY* IN POUNDS					
Shelf Type	Shelf Depth	FLAT			
		Evenly Loaded	Front Loaded	15° Down	30° Down
SUS-□□□	A 6" - 8"	300#	300#	250#	100#
	B 8" - 18"	500#	350#	250#	100#
	C 20" - 24"	500#	350#	250#	100#
STP-□□□	D 26" - 30"	400#	250#	200#	100#
	E 6" - 8"	300#	300#	250#	100#
	F 10" - 18"	500#	350#	250#	100#
HUS-□□□	G 20" - 24"	500#	350#	250#	100#
	H 26" - 30"	400#	250#	200#	100#
	I 14" - 18"	600#	n/a	n/a	n/a
SBS-□□□	J 20" - 30"	600#	n/a	n/a	n/a
	K 12" - 30"	600#	n/a	n/a	n/a
	L 12" - 30"	600#	n/a	n/a	n/a

*...Based on evenly distributed static loading.
 •...STP type shelves are "straight-in", horizontal insertion into upright slotting.

GONDOLA / WALL FIXTURE

ASY 046

FIXTURE LOADING - PRODUCT SAFETY

DO NOT EXCEED ANY OF THE MAXIMUM LOAD LIMITS IN THE FOLLOWING SECTIONS!

FRONT LOADED SHELVES

IMPORTANT! Front loaded shelves create the most likely situation for exceeding the fixture loading capacities. Compare the increases in inch/lb. loadings of front loaded shelves over evenly loaded shelves, PARTICULARLY ON WALL SECTIONS!

A front loaded shelf has a void between the back panel and the merchandise. Take one half the loaded area dimension plus the gap dimension at back and multiply times the weight on the shelf in order to determine individual inch/lb. load.

FRONT LOADED SHELVES ON GONDOLAS

- A1 7" + 4" = 11" x 300 lbs. or 3,300 inch/lbs.
- A2 7" + 4" = 11" x 400 lbs. or 4,400 inch/lbs.
- A3 9" + 4" = 13" x 500 lbs. or 6,500 inch/lbs.

SIDE A TOTAL = 14,200 inch/lbs.

- B1 6" + 6" = 12" x 300 lbs. or 3,600 inch/ lbs.
- B2 6" + 6" = 12" x 300 lbs. or 3,600 inch/ lbs.
- B3 8" + 6" = 14" x 300 lbs. or 4,200 inch/lbs.

SIDE B TOTAL = 11,400 inch/lbs.

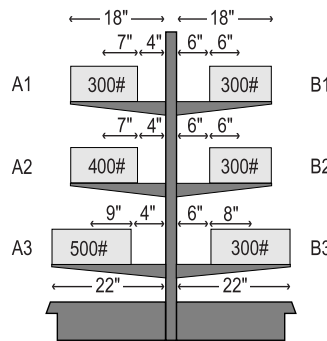

SUBTRACT B FROM A:
14,200 inch/lbs.
-11,400 inch/lbs.
2,800 inch/lbs.

SAFE! 2,800 INCH/LBS.
DOES NOT EXCEED
15,000 INCH/LBS.
MAXIMUM

FRONT LOADED SHELVES ON WALL SECTIONS

- C1 5" + 8" = 13" x 200 lbs. or 2,600 inch/lbs.
- C2 5" + 8" = 13" x 300 lbs. or 3,900 inch/lbs.
- C3 7" + 8" = 15" x 500 lbs. or 7,500 inch/lbs.

SIDE C TOTAL = 14,000 inch/lbs.

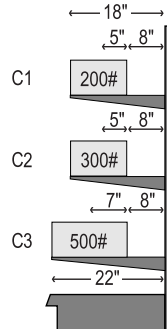

SAFE! 14,000 INCH/LBS.
DOES NOT EXCEED
15,000 INCH/LBS.
MAXIMUM

COLUMN LOADING

Column loading is the vertical load, measured in pounds, that can be applied on any upright. Each upright bears ONE HALF OF THE LOAD OF EACH SHELF THAT IT SUPPORTS. **MAXIMUM COLUMN LOAD IS 4,500 POUNDS ...DO NOT EXCEED!**

TOP VIEW OF GONDOLA SECTIONS

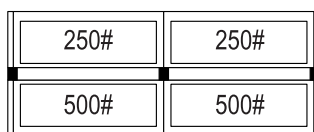

750 lbs. plus 750 lbs. = 1500 lbs.

1500 lbs. divided by 2 =
 750 lb. column load on the center upright

... CONTINUED:
 WALL SECTIONS ON NEXT PAGE...

GONDOLA / WALL FIXTURE

ASY 046

FIXTURE LOADING - PRODUCT SAFETY

COLUMN LOADING CONTINUED...

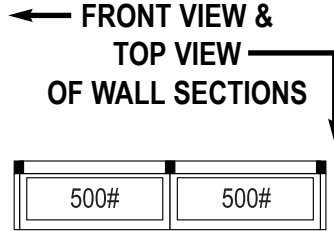
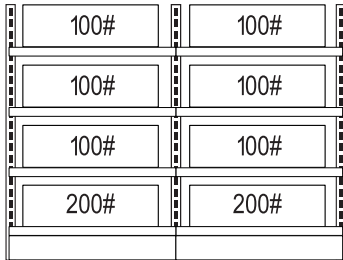

500 lbs. plus 500 lbs. = 1000 lbs.
1000 lbs. divided by 2 =
500 lb. column load on the center upright

OFFSET LOADING

Offset loading is measured in inch/pounds and represents the bending load at the base shoe connection and the upright. To determine if you exceed the load limit of the fixture, take the difference between the larger inch/lb. calculations on one side of the fixture and the inch /lb. calculations on the other. THIS DIFFERENCE CANNOT EXCEED 15,000 INCH/LBS. In the case of wall sections, the calculation for the one side CANNOT EXCEED 15,000 INCH/LBS.

EVENLY LOADED SHELVES ON GONDOLAS

Divide each shelf depth by 2...multiply times the weight on shelf to determine individual shelf load.

D1	18" / 2 = 9" x 300 lbs.	or 2,700 inch/lbs.
D2	18" / 2 = 9" x 400 lbs.	or 3,600 inch/lbs.
D3	22" / 2 = 11" x 500 lbs.	or 5,500 inch/lbs.

SIDE D TOTAL = 11,800 inch/lbs.

E1	18" / 2 = 9" x 300 lbs.	or 2,700 inch/lbs.
E2	18" / 2 = 9" x 300 lbs.	or 2,700 inch/lbs.
E3	18" / 2 = 11" x 300 lbs.	or 3,300 inch/lbs.

SIDE E TOTAL = 8,700 inch/lbs.

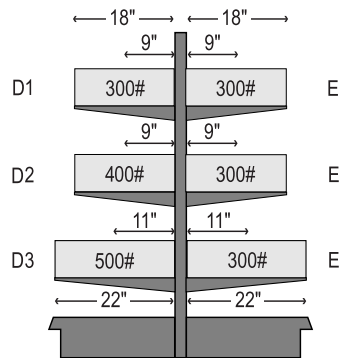

SUBTRACT E FROM D
11,800 inch/lbs.
- 8,700 inch/lbs.
3,100 inch/lbs.

SAFE! 3,100 INCH/LBS. DOES NOT EXCEED 15,000 INCH/LBS. MAXIMUM

EVENLY LOADED SHELVES ON WALL SECTIONS

Divide each shelf depth by 2...multiply times the weight on shelf to determine individual shelf load.

F1	18" / 2 = 9" x 300 lbs.	or 2,700 inch/lbs.
F2	18" / 2 = 9" x 400 lbs.	or 3,600 inch/lbs.
F3	22" / 2 = 11" x 500 lbs.	or 5,500 inch/lbs.

SIDE D TOTAL = 11,800 inch/lbs.

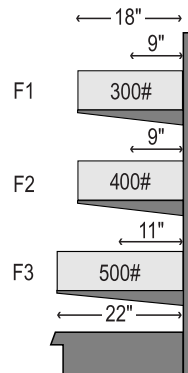

SAFE! 11,800 INCH/LBS. DOES NOT EXCEED 15,000 INCH/LBS. MAXIMUM

GONDOLA / WALL FIXTURE**ASY 046**

FIXTURE LOADING - PRODUCT SAFETY

RE-LEVELING OF OFFSET LOADED FIXTURES

AFTER THE FIXTURE IS LOADED, IF A GAPPING OF THE SHELVES APPEARS ON THE HEAVILY LOADED SIDE, IT IS POSSIBLE THE ORIGINAL INSTALLATION IS THE CAUSE.

CHECK THESE TWO CONDITIONS BEFORE PROCEEDING!

1. ALL UPRIGHTS MUST BE AT THE SAME HEIGHT!

A. Visually sight across the top of the fixture to check for high or low uprights.

B. If a row of shelves is near the top of the uprights, do they appear to rise or sag at one of the uprights.

TO CORRECT: Pull a stringline across the top of the uprights from end to end...Then,

IF UPRIGHTS TOO LOW on lightly loaded section...

a. Raise base shoe levelers on each side equally until upright touches stringline.

IF UPRIGHTS TOO HIGH on lightly loaded section...

a. Remove kickplates on both sides of the low upright.

b. Screw upright leveler out, or down, raising the top upright until it touches stringline.

c. Screw base shoe levelers down an equal number of turns until base shoes lock up against the upright.

IF UPRIGHTS TOO HIGH on lightly or heavily loaded section...

a. Remove kickplates on both sides of the high upright.

b. Screw upright leveler up into upright, this may solve the "too high" problem, if not...

c. Screw loose shoe levelers up into shoe an equal number of turns until top of upright touches stringline.

2. NONE OF THE SECTIONS IN THE RUN HAVE BEEN MOVED OUT OF ALIGNMENT

A. Visually sight along the front of the base shelves.

B. Compare the front of the base shelves to a tile line.

TO CORRECT: Facing the wedge shaped gap areas, physically push the section back into line, closing the gaps. Depending on the merchandise, it may be necessary to unload or partially unload the section before moving. Attempt to move the section by applying foot pressure at the kickplate joint only...if not possible,

a. Place a 2 x 4 block against the kickplate joint and tap back into alignment...or...

b. Use a jack and 2 x 4 block against kickplate joint... jack should be braced across the aisle against a long 2 x 4 spanning several kickplate joints.

IF THE ABOVE CONDITIONS ARE NOW CORRECT, look for shelf gaps on the heavily loaded side...the base shelf joint will be tight, but the upper shelves will have increasingly larger wedge shape gaps at the top, REMOVE KICKPLATES ON BOTH SIDES FOR AT LEAST ONE SECTION ON EITHER SIDE OF THE HEAVILY LOADED SECTION.

ON THE LIGHTLY LOADED SIDE,

a. Run upright levelers down to the floor.

b. Run base shoe leveler up into shoe until the pressure is off of it...1/4" free movement.

THEN...ON THE HEAVILY LOADED SIDE,

c. Begin at the first heavily loaded upright TO YOUR RIGHT, facing the heavily loaded side...run the base shoe leveler down until all the shelf gaps at that upright close tightly.

d. Repeat c. with remaining heavily loaded uprights, WORKING TO YOUR LEFT.

THEN...ON THE LIGHTLY LOADED SIDE,

e. Run loose levelers down until shoe locks up against the upright.

f. Replace kickplates on both sides.



P.O. BOX 729 / TERRELL, TEXAS 75160 / 972.563.5744 / 800.776.2349

P.O. BOX 177 / GOODWATER, ALABAMA 35072 / 205.839.6354 / 800.633.6282

**REV
D**

REV#	ECN#	REVISION	BY	DATE	REV#	ECN#	REVISION	BY	DATE
A	4865	Reformat, make math & # corrections	ACM	2/15/00	D		ADD NOTE TO NOT SEAT WSRP	AJB	4/30/02
B	5007	Revise diagrams on p4&5 to match catalog	ACM	4/14/00					
C		adjust laod rates on HUS	AJB	1/24/02					